

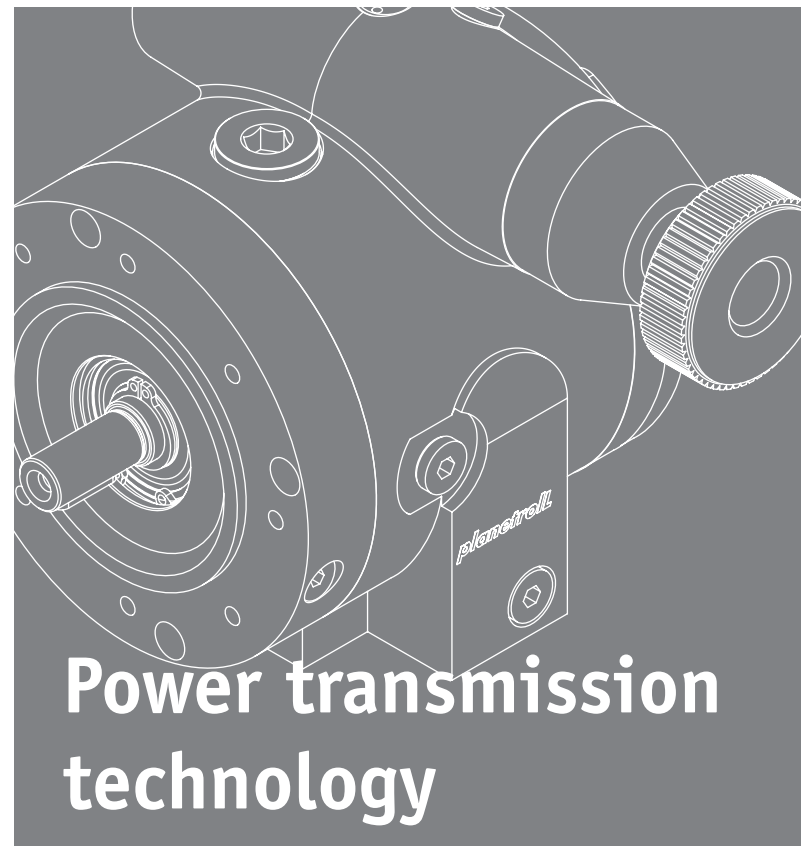

Ideas that find a home, take shape, combine to new form, unite once again, mature, gather force and gradually change our world. This results in progress, and the future is born. Welcome home to planetroll®.



## Stirring technology



## Power transmission technology

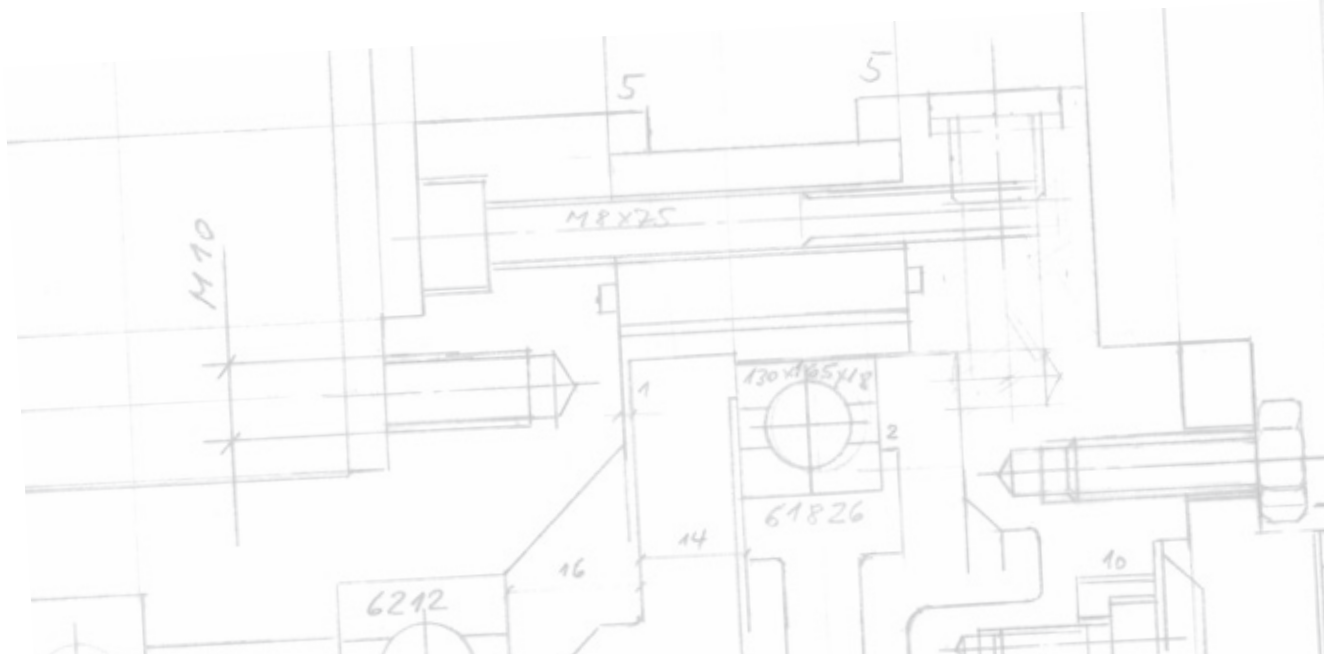



## Ideas are the driving force

Ideas are delicate plants. They thrive only within a healthy environment and require plentiful care in order to grow up to be successful products.

Since 1976, we have been offering a fertile breeding ground for forward-looking ideas at **planetroll®**, and are always giving our products new momentum and setting new benchmarks in our markets.

Today we are successfully engaged in two business areas. In **power transmission technology**, we are one of the world's leading manufacturers of variable-speed gearboxes for use in explosion-proof areas according to ATEX 95. As a further product in power transmission technology, we develop and produce planetary gearheads in standard and special versions.

In **stirring technology**, our customers benefit from our decades of experience in the development and design of stirrer drive units. As a system supplier and specialist in the Ex-range, here we plan, develop and build complete solutions for plants - from consulting, through design, construction and manufacturing, to the installation and commissioning of the stirrers.

For both business areas, we offer a wide range of the best tried-and-tested products. With our expert knowledge, good ideas and considerable flexibility, we would be particularly glad to develop application-specific solutions for you. Try it and give us a task - you will be convinced by the quality of our solutions and products.

# Ideas are the driving force

## A global leader in explosion protection

ATmosphere EXplosive ATEX



## The planetroll® environment for good ideas

✓ **Knowledge:** In the industry we are known for our engineering know-how, creativity, precision and “made in Germany” innovations. We're proud of this. And therefore, we are constantly working on our products and processes, and developing them for the benefit of our customers.

✓ **Passion:** As the saying goes, our spirit is the guide, our emotions are the energy. That is for sure. It is passion that drives us to find the best solutions for our customers' applications. The result is individual technique of the planetroll® brand.



*Certified according to  
DIN EN ISO 9001:2008*

✓ **Performance:** As a company working with stirring technology and power transmission technology, our engineers and technicians work on our customer's tasks every day. Our tools of the trade: qualified technical consultancy, development and construction using the latest 3D CAD technology, testing and measuring technology, as well as specialized production technologies.

✓ **Quality:** We are certified according to DIN EN ISO 9001:2008. But for us, quality means much more. It entails promises and responsibility toward our customers. No product leaves our house without quality control. Customer-oriented behavior is an integral part of our corporate culture.

✓ **Openness:** Today we supply customers all over the world. Twenty-one agencies abroad on five continents make planetroll® a cosmopolitan global player. We look single-mindedly toward the future and, are open and ready to recognize the good ideas of tomorrow.



# Power transmission technology – the world of torques

Knowledge, experience and good ideas – this is what **planetroll®** has stood for, for over 30 years. The result: Our invention of the variable-speed gearbox according to the rolling ball principle, advanced power transmission control systems and planetary gearheads.

And because steadiness gives rise to reliability, nowadays a lot of well-known enterprises rely on power transmission technology from **planetroll®**. No matter what kind of industry – the innovative technology and absolute reliability of our products convince and inspire.

Therefore, and thanks to our continuous development, we are now a leading provider of explosion-proof variable-speed drives according to ATEX 95. And there's more: Our products meet the ever stricter requirements in the hygiene sector and are available in silicone-free versions.

## Our standards:

- ATEX compliant for zone 1 and 21
- GMP, FDA, BISSC, NSF/USDA-H1 compliant
- Silicone-free versions

## Variable speed gearboxes **plaromaster® MR**

**plaromaster® MR** are the world's leading variable-speed gearboxes in the explosion-proof area according to ATEX 95. They use the principle of rolling balls and are infinitely adjustable from and to zero speed, even with the highest starting or breakaway torques. They can be operated remotely by means of a hand wheel, or electrically. Due to the characteristics of the system, they cannot slip through – complex and costly ATEX external monitoring is not necessary.



plaromaster®

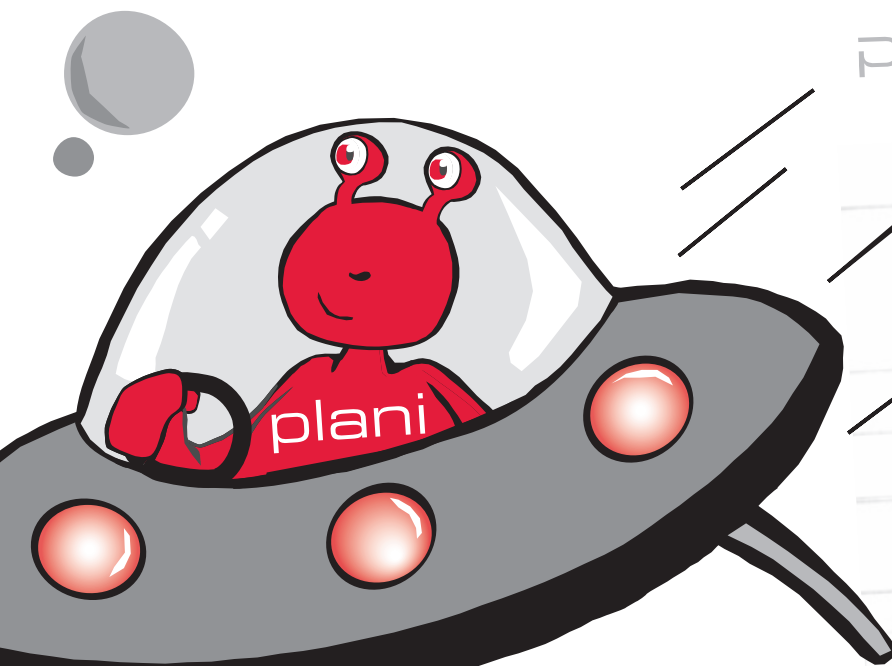

# planetdrive®

## Planetary gearheads planetdrive® PD

planetdrive® PD is the well-established planetary gearhead from **planetroll®**. It is characterized by first-class reliability, a flexible mounting system, short delivery times and a very attractive price. The planetdrive® PD planetary gearheads are self-centring, equipped with an adapter flange system and axial length compensation, and are also maintenance-free thanks to lifetime lubrication.



## Low-backlash planetary gearheads planetdrive® PDH

The single-stage and double-stage low-backlash planetary gearheads from **planetroll®** ensure a minimum torsional backlash and enormous torsional rigidity for the highest precision and dynamics. Furthermore, they offer high radial forces, extremely high resistance against tilt, perfect control precision and extremely low-noise running thanks to an optimized tooth form.

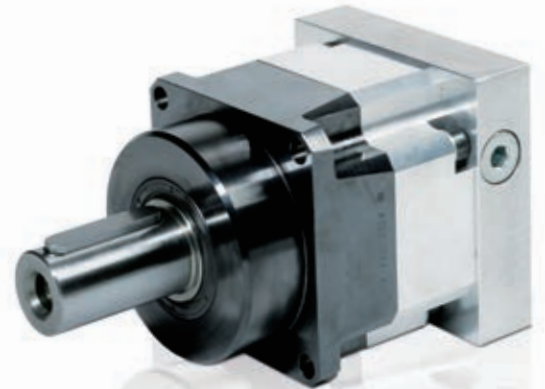

You can also obtain the following from planetroll®:

- Servo control engineering
- Geared motors
- Special gearboxes for customized solutions

Our standards:

- ATEX compliant for zone 1 and 21
- GMP, FDA, BISSC, NSF/USDA-H1 compliant
- Silicone-free versions

# Stirring technology – as individual as our customers

Tell us what you would like to stir and we will show you the best solution for your task. This is a simple message, but the best way of describing our offering in the field of stirring technology.

For **planetroll®** offers you a wide range of complete stirrer systems and, in addition, the professional advice of our experts from a single source. Whether you require variable speed gear-boxes, frequency converters or a constant-speed power transmission solution – we supply you with the optimum custom-designed stirrer unit as well as the most suitable stirring element for your task.

Naturally, we also supply the complete stirrer control technology. You can rely on our knowledge acquired from a wide variety of sectors and countless stirring tasks.

Incidentally, our stirrers and all components are available in both explosion-proof and non explosion-proof versions, in accordance with Directive 94/9/EC (ATEX 95). The standards GMP, FDA, BISSC, NSF/USDA-H1 are fulfilled. Besides this, we also provide you with silicone-free power transmission solutions.

## Individual stirrers for all needs

From one source, we offer the consulting, design, construction and manufacturing of complete stirrers for all fields of application.

## Our branches of industry:

- Foods
- Pharmaceuticals
- Chemicals
- Paper
- Paints
- Varnish
- Plastics
- Ceramics and many more.

## Especially for laboratories and pilot plant stations:

We have developed our laboratory stirrer **plaroJet®** specifically for these areas of application – also in explosion-proof execution.

*Variety of products for all your stirring tasks*

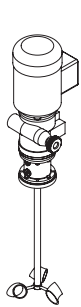

Small-scale stirrers for Hobbecks HRW and drum stirrers

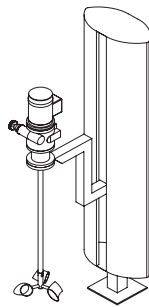

Stand stirrers SRW with manual or electric stroke

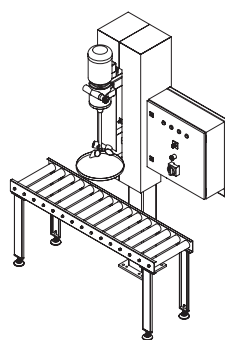

Process-integrated stirrer plants

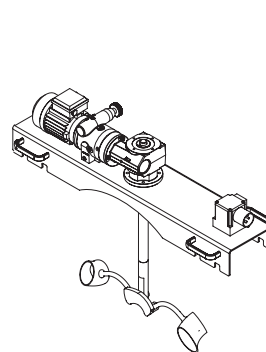

Container stirrers CRW

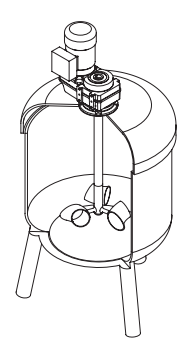

Top-mounted stirrers ARW and large-scale stirrers

*Other designs: Laboratory stirrers, tank stirrers, sublevel stirrers*

Hollow-shaft stirring element RuvaStar®

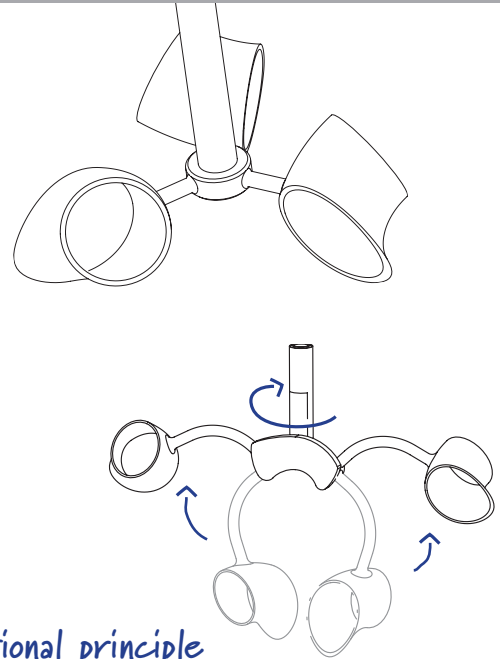

*Functional principle  
Stirring element tiltable  
and easily disassembled*

# Our building blocks for your best stirrer plant

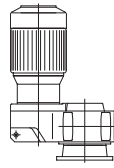

## Power transmission options

### **plaromaster® MR gearbox with variable speed**

Power: 0.027 - 11 kW  
Torque: 1 - 3,000 Nm

### **Frequency converter geared motor with variable speed**

Power: 0.06 - 200 kW  
Torque: 1 - 90,000 Nm

### **Geared motor with constant speed**

Power: 0.06 - 200 kW  
Torque: 1 - 90,000 Nm

## Stirring shaft options

- Different types of connection to gearbox and stirring element
- Stirring shaft diameter: from 10 to 150 mm
- Stirring shaft materials: Stainless-steel and others on request
- GMP and FDA compliant

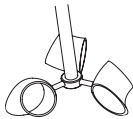

## Stirrer control system options

- Design according to customer request
- From simple speed control through to integration in process controls

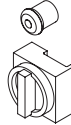

*Our variety ranges from propeller over blade through to hollow-shaft stirring element*

## Stirring element options

We offer you the most suitable stirring element for your task from liquid to high-viscosity mediums. Our stirring elements, in standard or special versions, which can, among other features, be tilted for container and drum applications, offer you many advantages:

Short mixing times, no air induction, no foaming, no heating, energy saving due to low speeds, gentle product stirring, universally usable for almost all tasks, lightweight construction, the single-stage ground-level design without additional components inside the container is generally sufficient, pass-through operation possible.

# Maximum diversity and flexibility

## Contact

**planetroll® GmbH & Co. KG**  
Brunnenbergstrasse 11-13

D-89597 Munderkingen

phone  
or

+49 7393 9518-0  
+49 700 planetroll

fax  
e-mail

+49 7393 9518-98  
office@planetroll.com

Catalog ZH no. 07/14-02\_000

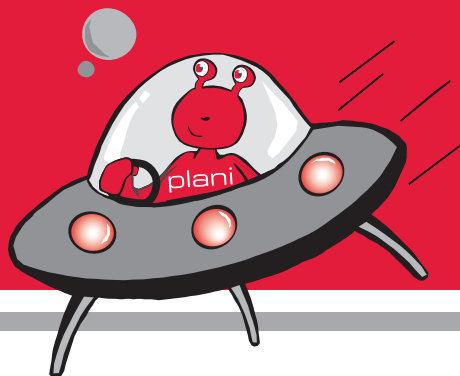

[www.planetroll.com](http://www.planetroll.com)



planetroll® stirring and power transmission technology:  
stirred by ideas and driven by innovations